

## Features

Supports the Onsemi ArrayC-30035-16P-PCB  
4x4 array of 3mm SiPMs

“VB” variant: Vertical signal connector located on the back, array located on the front

Wideband amplifier per SiPM

DC-coupled signal path

Low power consumption

Precision temperature sensor

Mounting holes for #4 or M3 hardware

## Specifications

### SiPM Signal Amplifiers

Gain	750Ω transimpedance gain
Output voltage	0 → -1V into 100Ω
Output impedance	100Ω
Output current	50mA maximum

### Temperature Sensor

Output voltage	500mV + 10mV per °C
Output current	10mA
Output impedance	100Ω
Accuracy	±0.5°C

### Bias Voltage

Voltage clamp	+28V typical (refer to SiPM data) 47V Zener diode 500mW maximum
---------------	---

### Amplifier Power (±VA)

Current	±2.8V → ±5.5V maximum ±30mA typical (I <sub>q</sub> , no signal, no load)
---------	---

### Signal Connector

Mating assembly	Vertical 40-pin 2-row latch-eject header with 0.050” pin pitch Samtec FFSD-20-D-XX.XX-01-N (XX.XX = length in inches)
-----------------	---

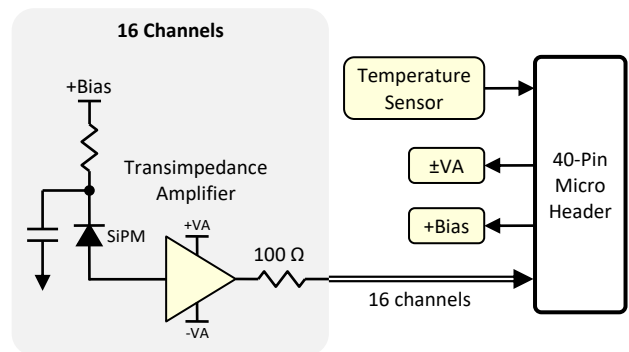
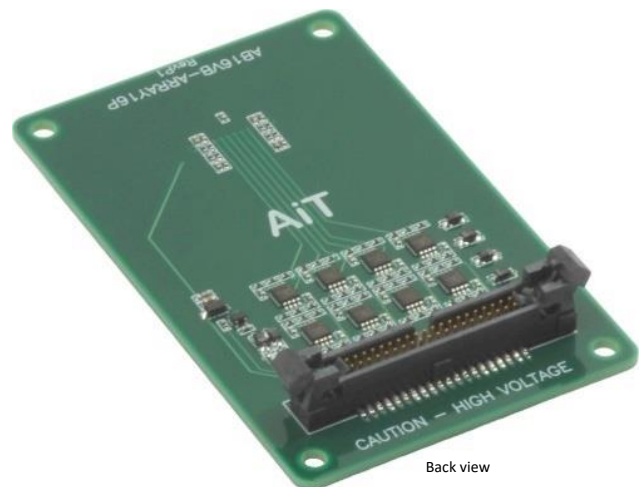
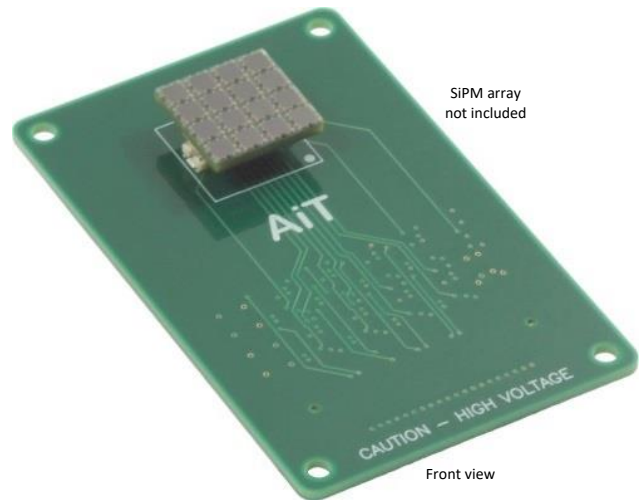

**Typical Signals**

Source = Laser; Receiver = ABR16, channel 6, minimum gain; Bias = +29V; FFSD cable = 36"

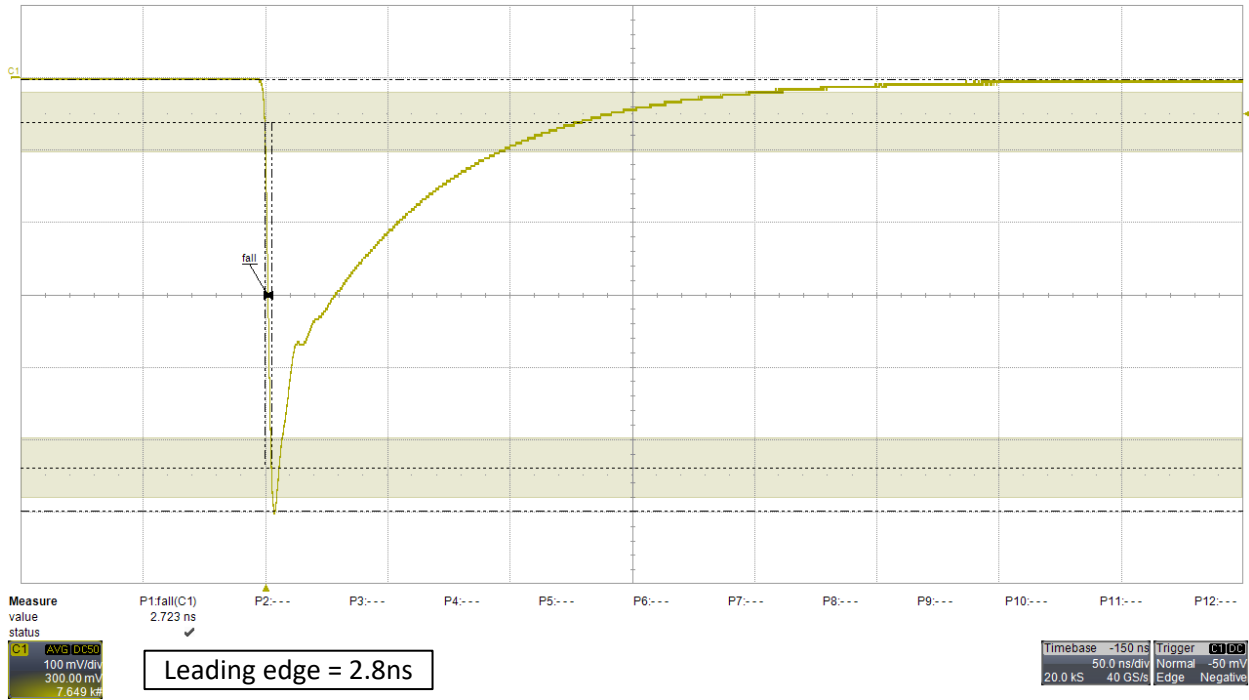

Source = LYSO emission; Receiver = ABR16, channel 6, minimum gain; Bias = +29V; FFSD cable = 36"; persistence display

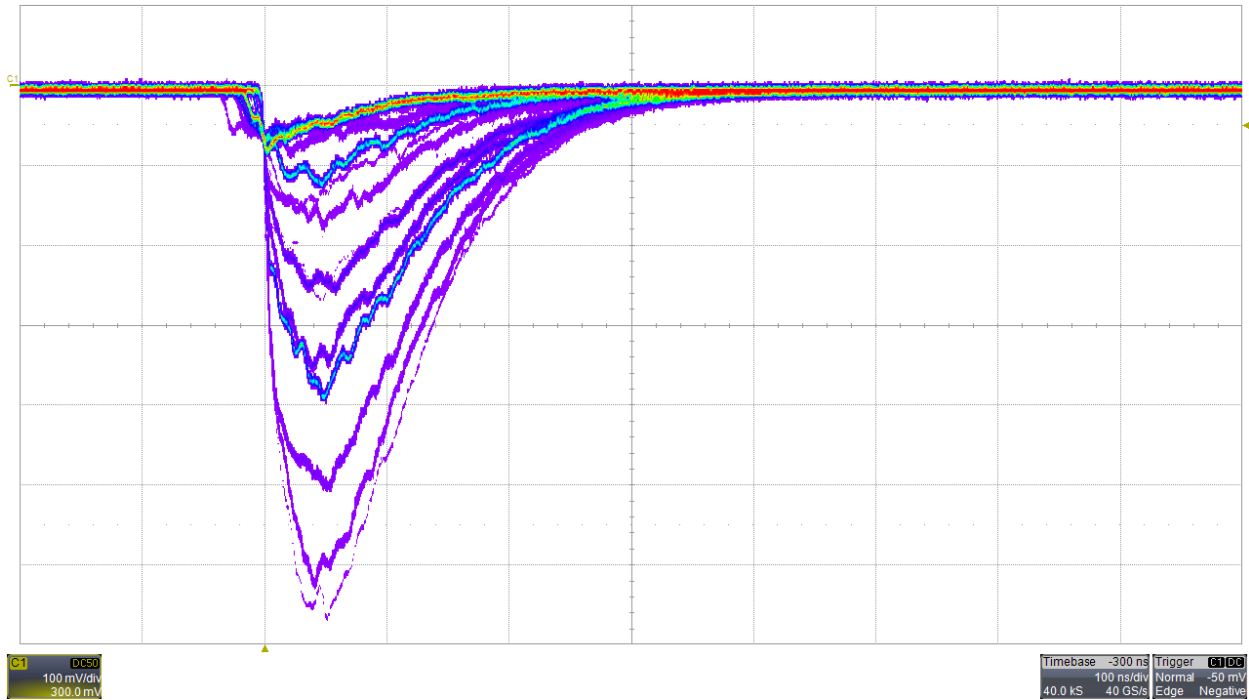

**Mechanical**

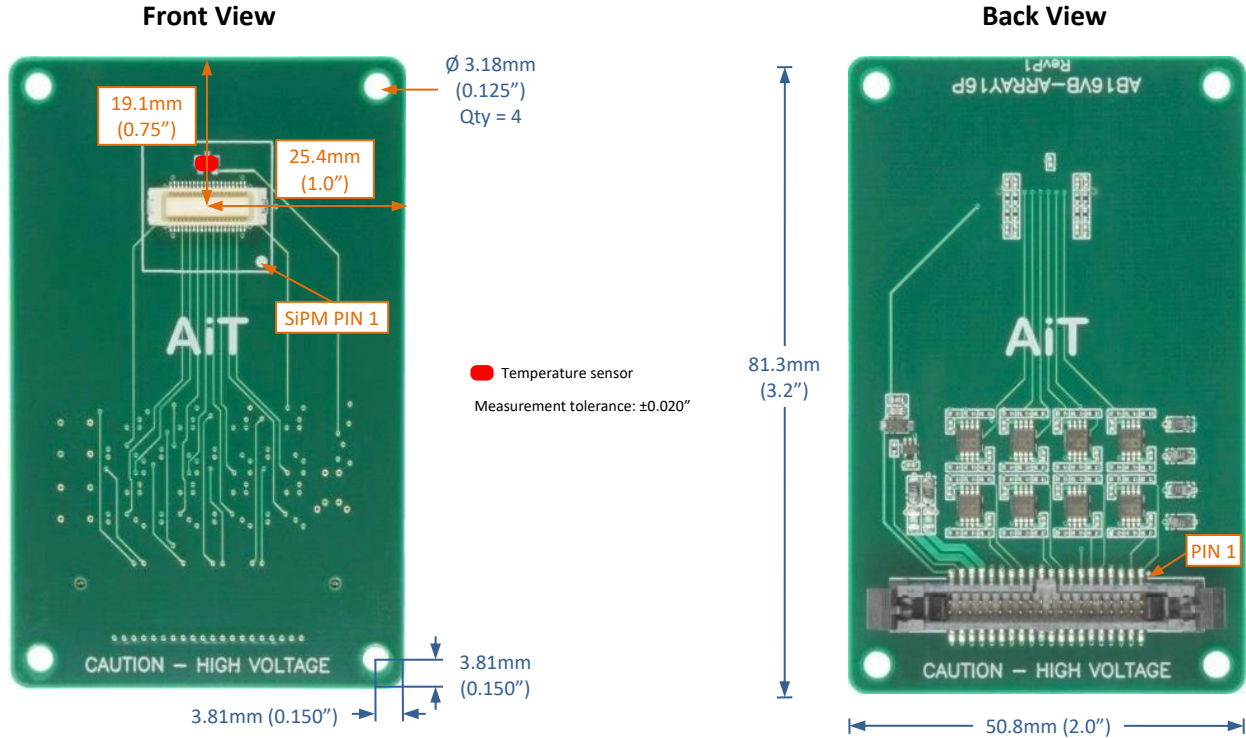

**Signal Connector**

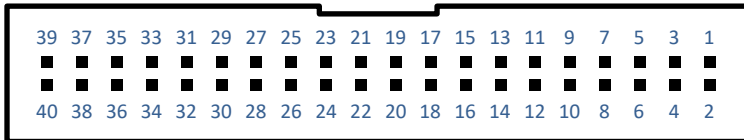

40-pin 0.050" vertical latch-eject header

**Channel Map**

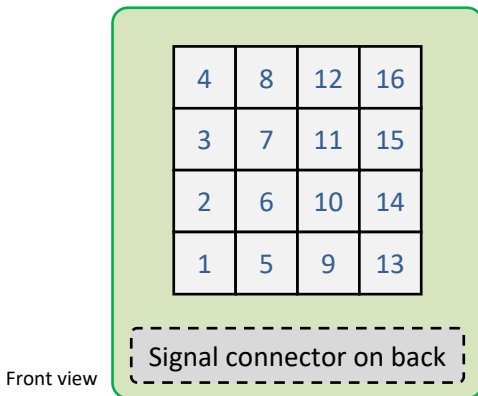

Pin	Function	Pin	Function
1	Bias	2	Ground
3	Temperature	4	Ground
5	Channel 1	6	Ground
7	Channel 2	8	Ground
9	Channel 3	10	Ground
11	Channel 4	12	Ground
13	Channel 5	14	Ground
15	Channel 6	16	Ground
17	Channel 7	18	Ground
19	Channel 8	20	Ground
21	Channel 9	22	Ground
23	Channel 10	24	Ground
25	Channel 11	26	Ground
27	Channel 12	28	Ground
29	Channel 13	30	Ground
31	Channel 14	32	Ground
33	Channel 15	34	Ground
35	Channel 16	36	Ground
37	-VA	38	Ground
39	+VA	40	Ground

## 16-Channel Active Base Readout Kit

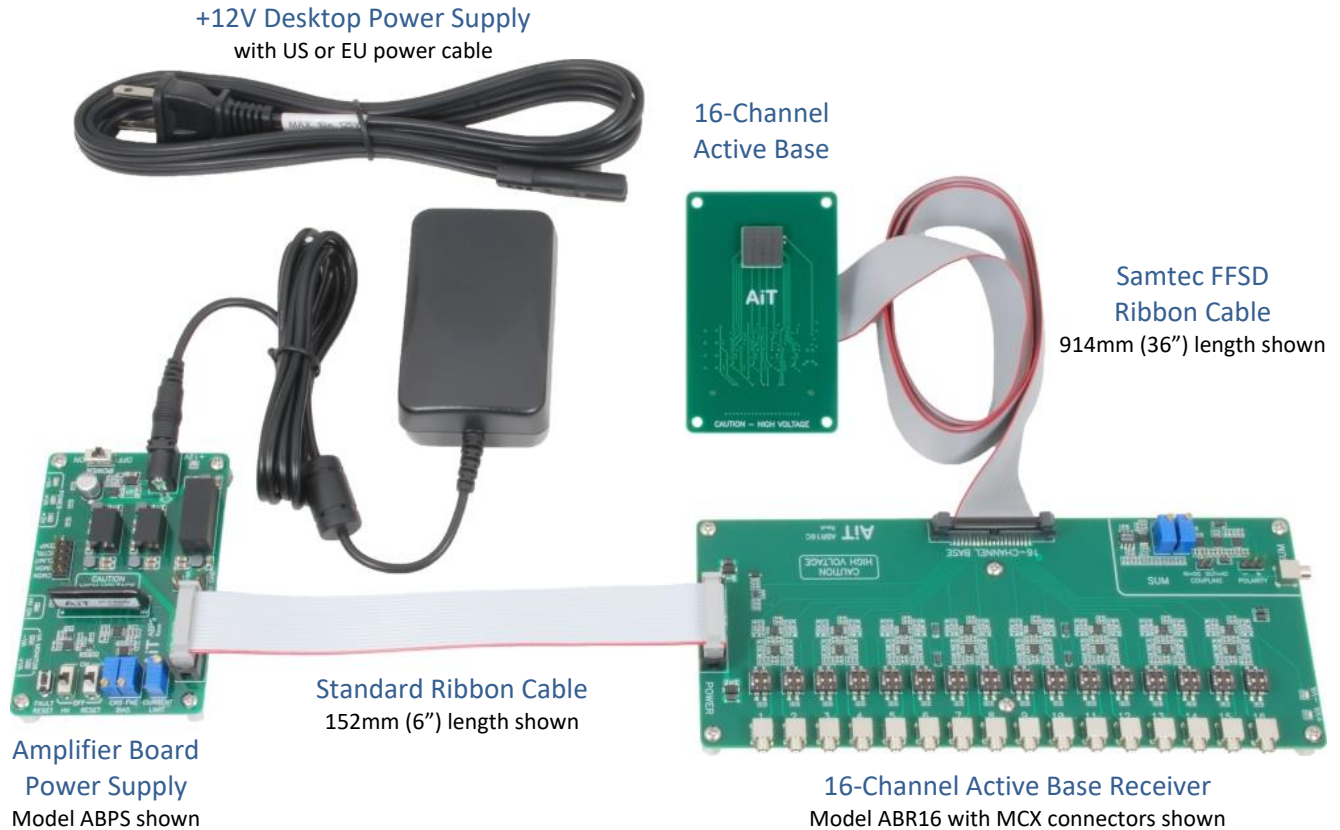

### Components

Each component is available separately. Refer to each datasheet for details.

The Active Base includes a 914mm (36") Samtec FFSD micro-pitch ribbon cable.

The Amplifier Board Power Supply includes a 12V desktop power supply and a HV80 bias voltage power supply.

The 16-channel Active Base Receiver includes a 152mm (6") power supply ribbon cable and a breakout board to connect any external power supply.

## Safety Information



### **WARNING – High Voltage**

- High voltage may be present during operation
- High voltage stored on capacitors may be present after power is removed
- Improper handling may result in personnel injury or equipment damage

This high-voltage device must be used only by personnel trained and qualified in safe handling, installation, and operation of high-voltage equipment.



### **CAUTION – Electrostatic Discharge (ESD) Sensitivity**

The circuit board can be damaged by electrostatic discharge. Observe precautions for handling electrostatic sensitive devices. Handle only at static-safe workstations.

## High-Gain Photodetectors

High-gain photodetectors such as silicon photomultipliers may conduct damaging currents if exposed to high optical signal levels while the bias voltage is applied, or if the bias voltage exceeds the recommended operating range. These devices must be operated only in low-light conditions, and only within the manufacturer's recommended bias voltage range.

## Handling and Disassembly

This product may be provided with a protective enclosure. Disassembled enclosure components and circuit boards may contain sharp edges. Take appropriate safety precautions while assembling or disassembling the enclosure and handling disassembled components.

## Indoor Use Only

Do not operate this product in a wet or damp environment. Do not operate in an explosive atmosphere.

Use of this product, and AiT Instruments' liability related to use of this product, is further governed by AiT Instruments' standard terms and conditions of sale, which were provided upon purchase of this product.