

Features

Supports the Hamamatsu S13361-6050AE-04
4x4 array of 6mm MPPCs

“VB” variant: Vertical signal connector located on the back, array located on the front

Wideband amplifier per SiPM

DC-coupled signal path

Low power consumption

Precision temperature sensor

Mounting holes for #4 or M3 hardware

Specifications

SiPM Signal Amplifiers

Gain	750 Ω transimpedance gain
Output voltage	0 \rightarrow -1V into 100 Ω
Output impedance	100 Ω
Output current	50mA maximum

Temperature Sensor

Output voltage	500mV + 10mV per $^{\circ}$ C
Output current	10mA
Output impedance	100 Ω
Accuracy	\pm 0.5 $^{\circ}$ C

Bias Voltage

Voltage clamp	+56V typical (refer to SiPM data) 68V Zener diode 375mW maximum
---------------	---

Amplifier Power (\pm VA)

Current	\pm 30mA typical (I _q , no signal, no load)
---------	---

Signal Connector

Mating assembly	Vertical 40-pin 2-row latch-eject header with 0.050" pin pitch Samtec FFSD-20-D-XX.XX-01-N (XX.XX = length in inches)
-----------------	---

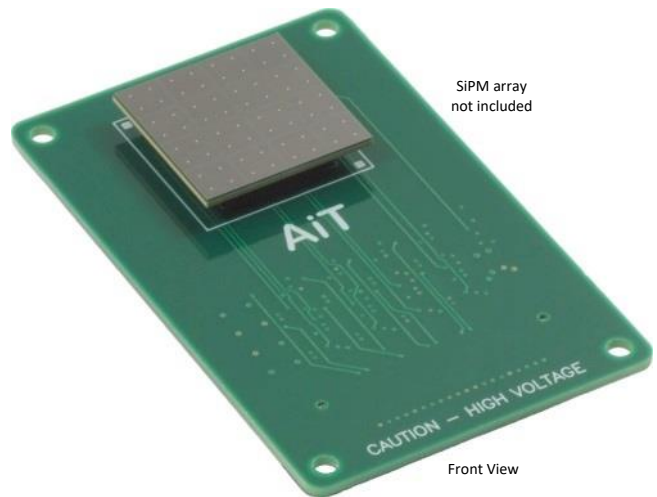

Front View

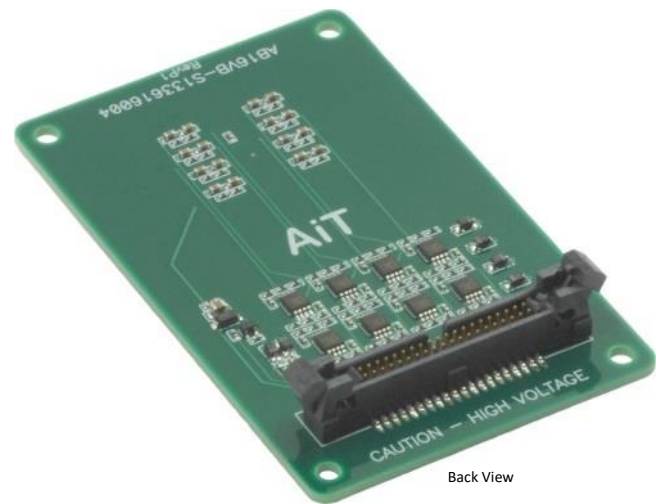

Back View

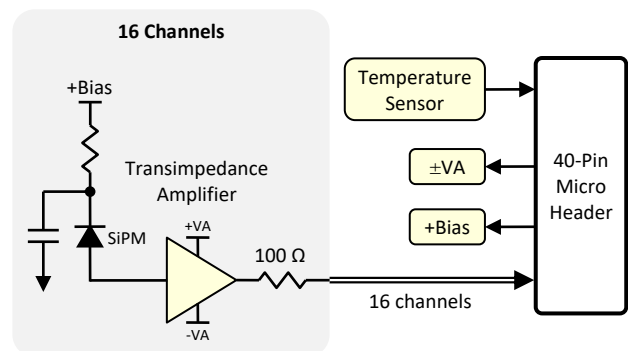

Typical Signals

Source = Laser; Receiver = ABR16, channel 5, minimum gain; Bias = +55V; FFSD cable = 36"

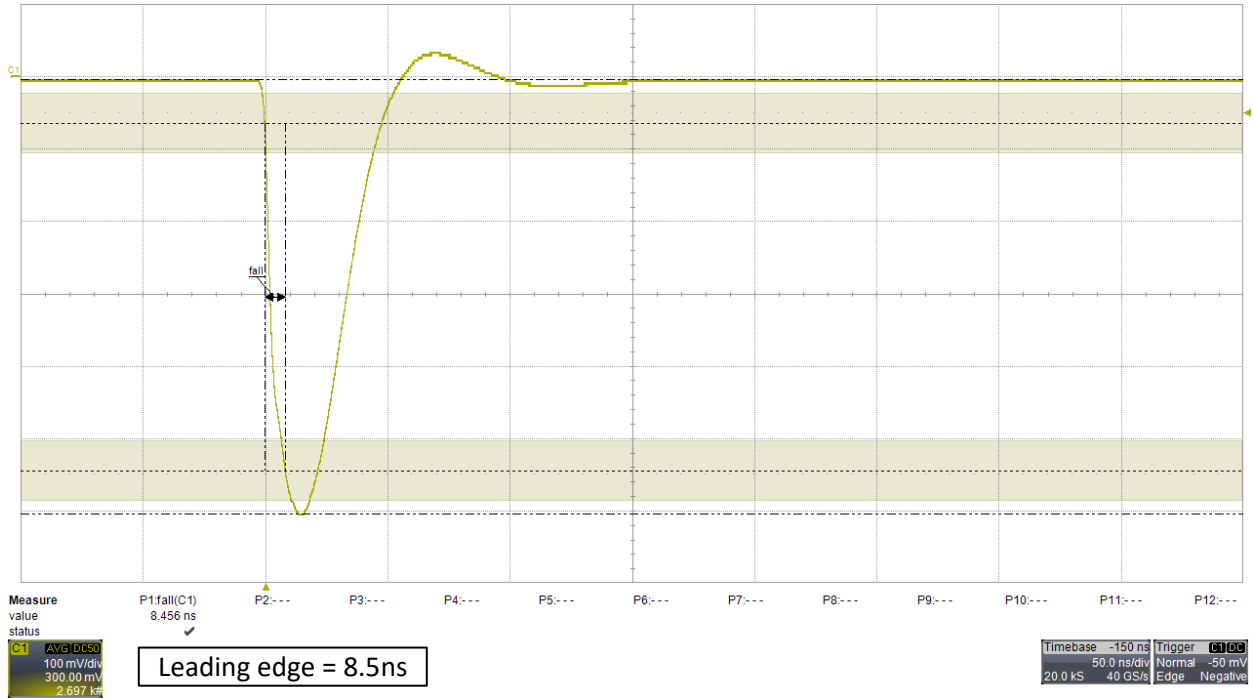

Source = LYSO emission; Receiver = ABR16, channel 5, minimum gain; Bias = +53V; FFSD cable = 36"

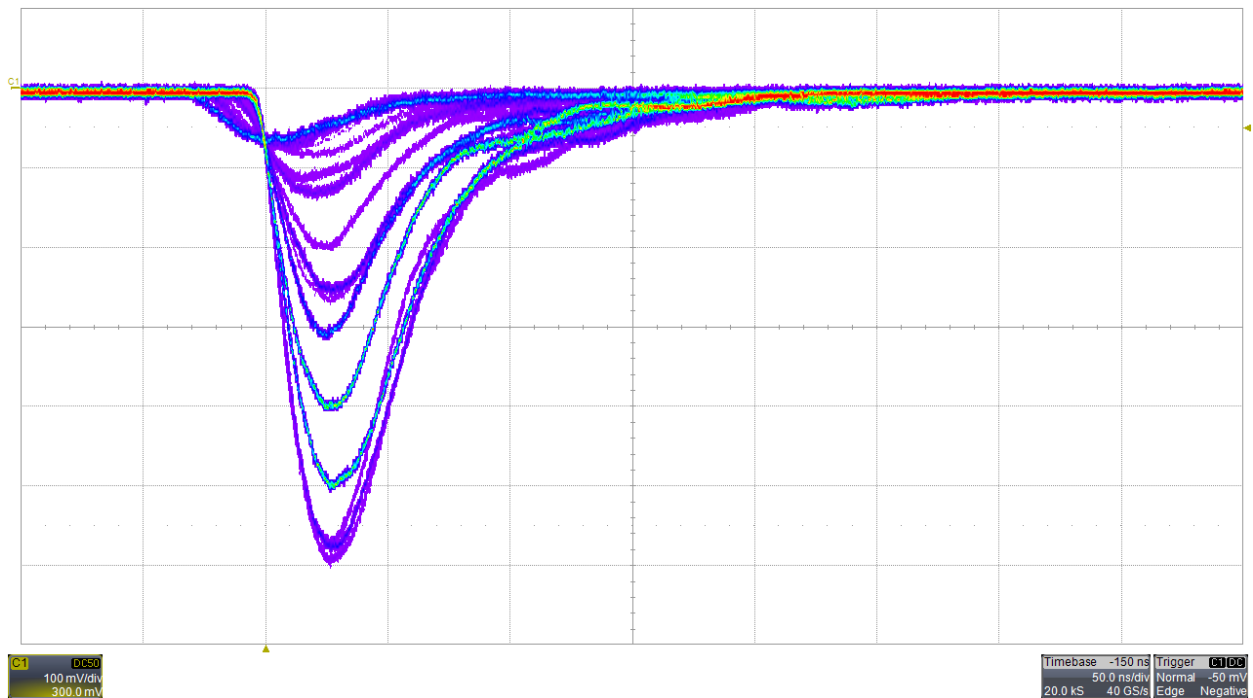

Mechanical

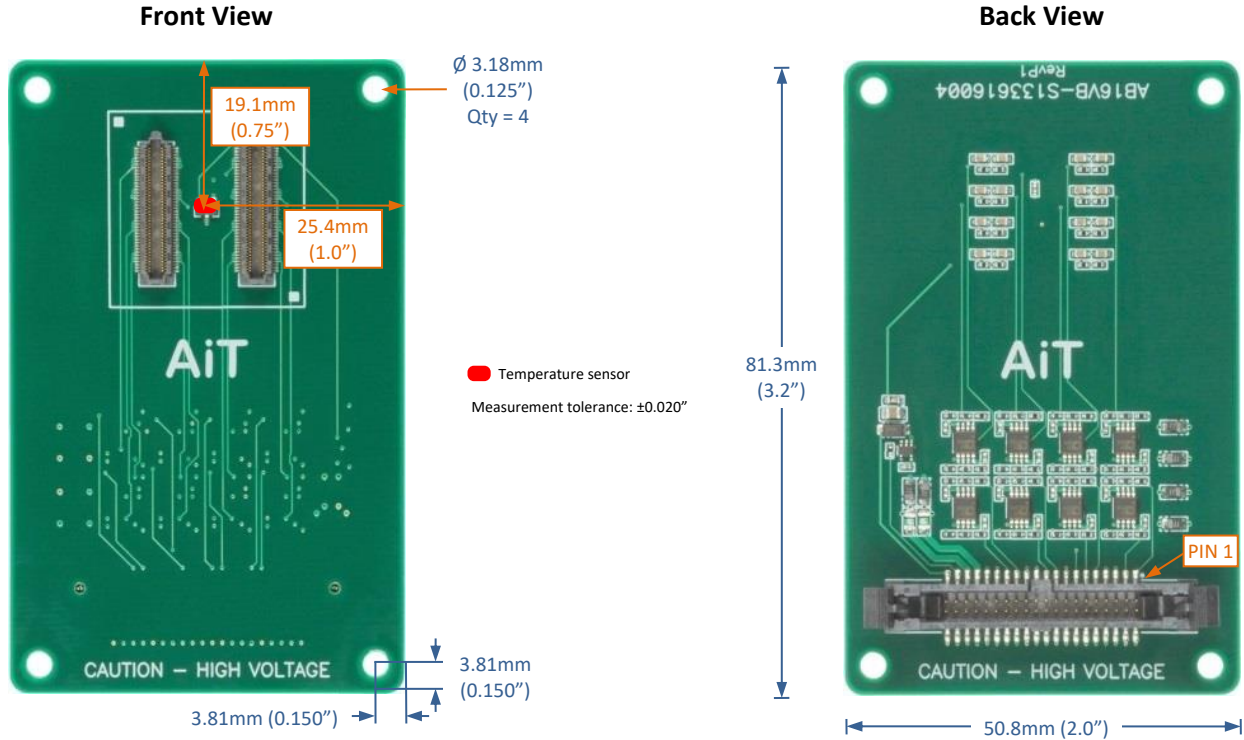

Signal Connector

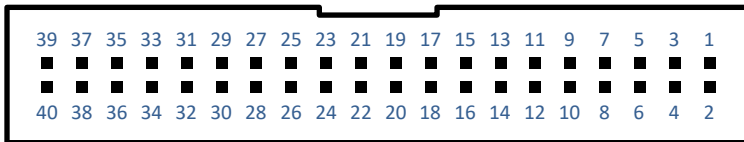

40-pin 0.050" vertical latch-eject header

Channel Map

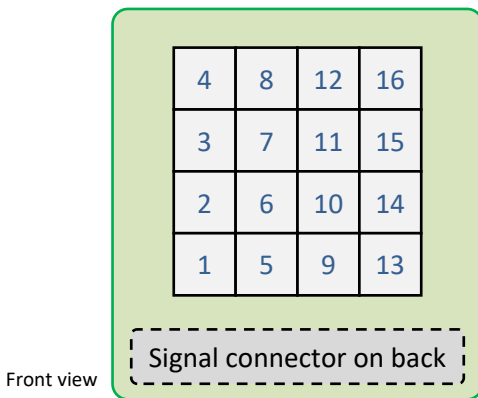

Front view

Pin	Function	Pin	Function
1	Bias	2	Ground
3	Temperature	4	Ground
5	Channel 1	6	Ground
7	Channel 2	8	Ground
9	Channel 3	10	Ground
11	Channel 4	12	Ground
13	Channel 5	14	Ground
15	Channel 6	16	Ground
17	Channel 7	18	Ground
19	Channel 8	20	Ground
21	Channel 9	22	Ground
23	Channel 10	24	Ground
25	Channel 11	26	Ground
27	Channel 12	28	Ground
29	Channel 13	30	Ground
31	Channel 14	32	Ground
33	Channel 15	34	Ground
35	Channel 16	36	Ground
37	-VA	38	Ground
39	+VA	40	Ground

16-Channel Active Base Readout Kit

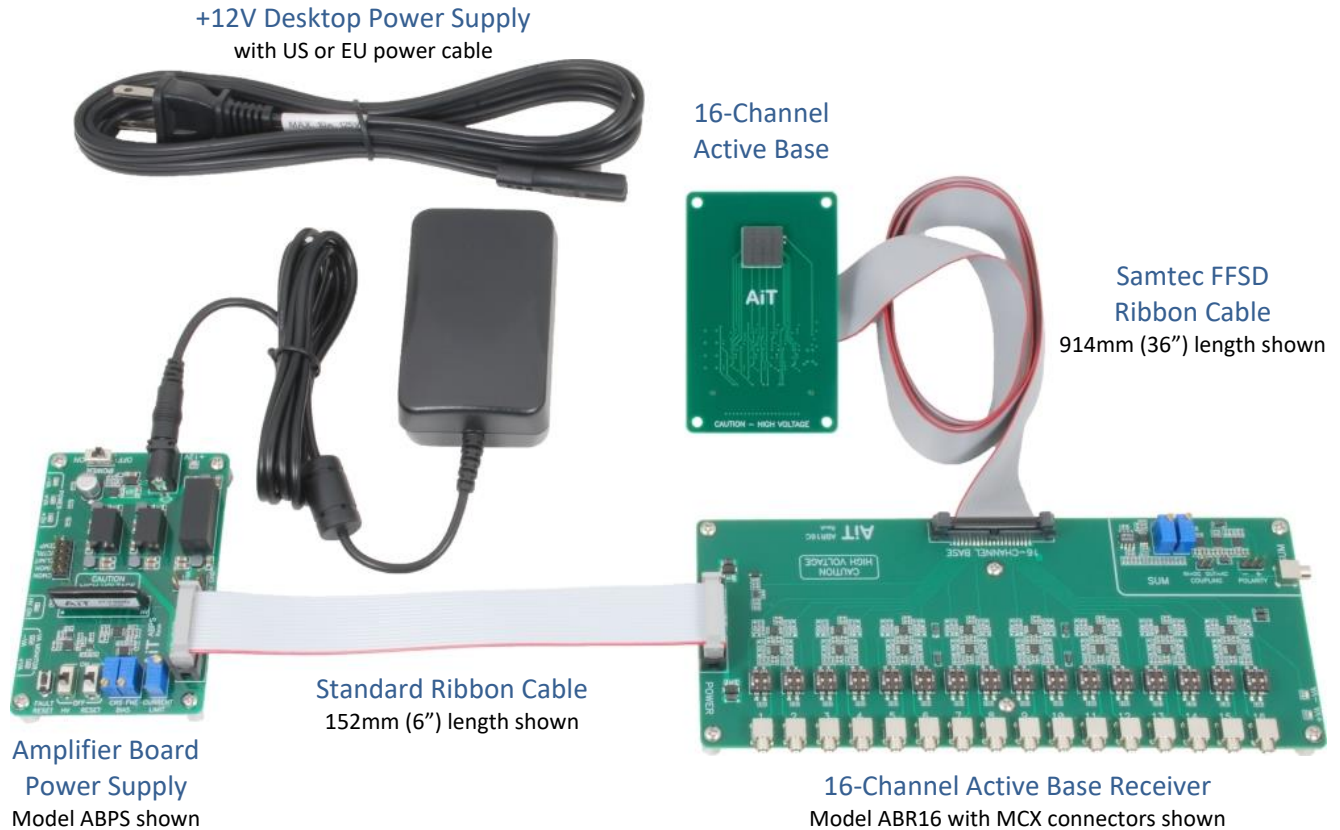

Components

Each component is available separately. Refer to each datasheet for details.

The Active Base includes a 914mm (36") Samtec FFSD micro-pitch ribbon cable.

The Amplifier Board Power Supply includes a 12V desktop power supply and a HV80 bias voltage power supply.

The 16-channel Active Base Receiver includes a 152mm (6") power supply ribbon cable and a breakout board to connect any external power supply.

Safety Information



WARNING – High Voltage

- High voltage may be present during operation
- High voltage stored on capacitors may be present after power is removed
- Improper handling may result in personnel injury or equipment damage

This high-voltage device must be used only by personnel trained and qualified in safe handling, installation, and operation of high-voltage equipment.



CAUTION – Electrostatic Discharge (ESD) Sensitivity

The circuit board can be damaged by electrostatic discharge. Observe precautions for handling electrostatic sensitive devices. Handle only at static-safe workstations.

High-Gain Photodetectors

High-gain photodetectors such as silicon photomultipliers may conduct damaging currents if exposed to high optical signal levels while the bias voltage is applied, or if the bias voltage exceeds the recommended operating range. These devices must be operated only in low-light conditions, and only within the manufacturer's recommended bias voltage range.

Handling and Disassembly

This product may be provided with a protective enclosure. Disassembled enclosure components and circuit boards may contain sharp edges. Take appropriate safety precautions while assembling or disassembling the enclosure and handling disassembled components.

Indoor Use Only

Do not operate this product in a wet or damp environment. Do not operate in an explosive atmosphere.

Use of this product, and AiT Instruments' liability related to use of this product, is further governed by AiT Instruments' standard terms and conditions of sale, which were provided upon purchase of this product.