

## Summary

### Features

- Supports the SensL ArraySM-8 and ArraySB-8 8x8 array of 6mm SiPMs
- Wideband amplifier per row and column, 16 total
- Patent-pending diode-coupled readout, superior to traditional resistive readout
  - Improved spatial uniformity
  - Faster rise time
  - Reduced image noise
- < 20ns rise time
- DC-coupled signal path
- Low power consumption
- Precision temperature sensor

### Mechanical

- Mounts entirely within the perimeter of the SiPM array for 4-sided tileable installation
- 4 mounting holes supports #2 hardware
- 0.050" pitch signal connector uses low-profile micro IDC cable assemblies for versatile placement

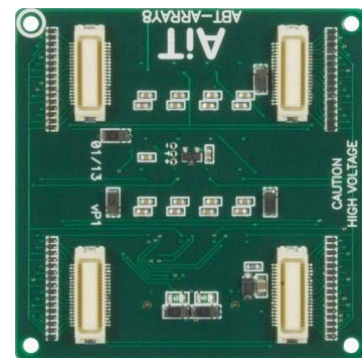
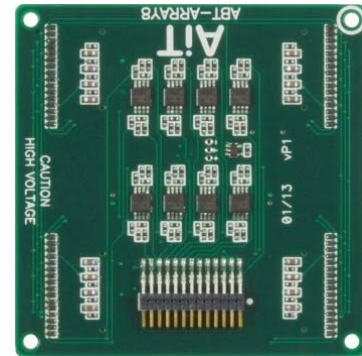

(Top View)

SiPM array not included

(Bottom View)

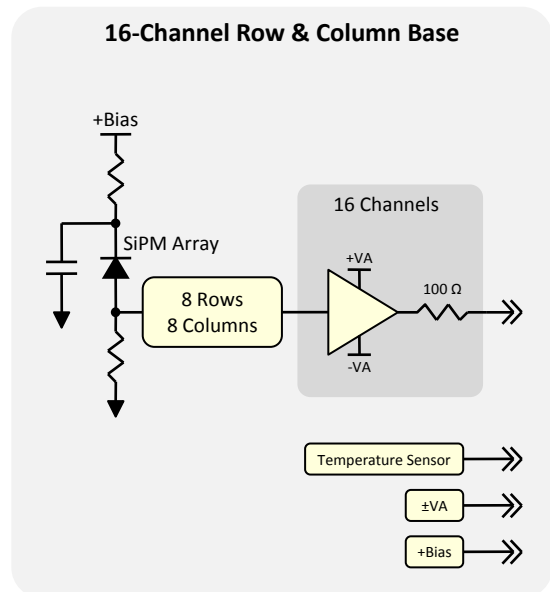

**Specifications**

**Position Signal Output**

Channels	16
Encoding	8 rows & 8 columns
Encoder gain	750Ω transimpedance gain (high-Z load)
Rise time	< 20 ns
Output voltage	0 → -1V (100Ω load)
Output impedance	100Ω
Output current	50mA max.

**Temperature Sensor**

Output voltage	500mV + 10mV per °C
Output current	10mA
Output impedance	100Ω
Accuracy	±0.5°C

**Bias Voltage**

+27.6V typ. for the ArraySB-8  
+29.5V typ. for the ArraySM-8

Over-voltage clamp 47V Zener diode

**Amplifier Voltage (±VA)**

±2.8V typ.; ±5V max.

Current ±30mA typ.  
(Iq, no signal, no load)

**Signal Connector**

Right angle 26-pin 2-row header  
0.050" pin pitch

Mating assembly Samtec FFSD-13-D-XX.XX-01-N  
(XX.XX = length in inches)

**Array8**

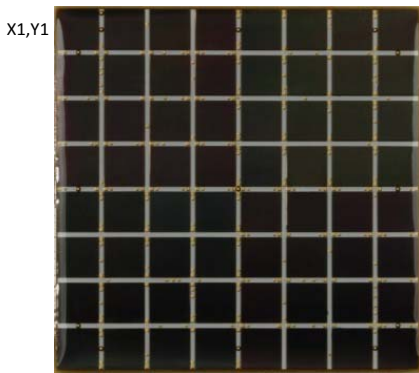

**Array Channel Map**

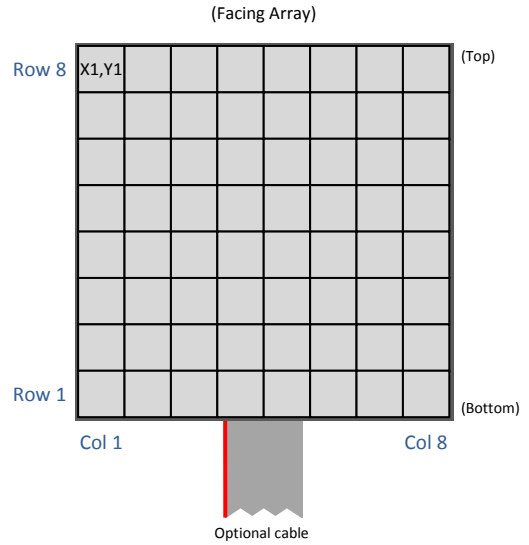

**Signal Connector**

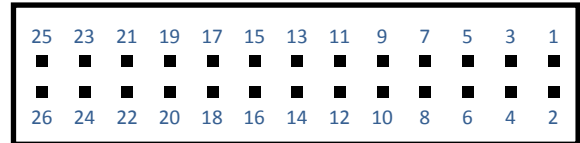

PCB Side View

Pin	Function	Pin	Function
1	Row 1	2	Temperature
3	Row 2	4	GND
5	Row 4	6	Row 3
7	Row 5	8	GND
9	Row 6	10	Row 7
11	Row 8	12	-VA
13	Column 1	14	GND
15	Column 2	16	+VA
17	Column 4	18	Column 3
19	Column 5	20	GND
21	Column 6	22	Column 7
23	Column 8	24	GND
25	+Bias	26	GND

**Mechanical**

**Top View**

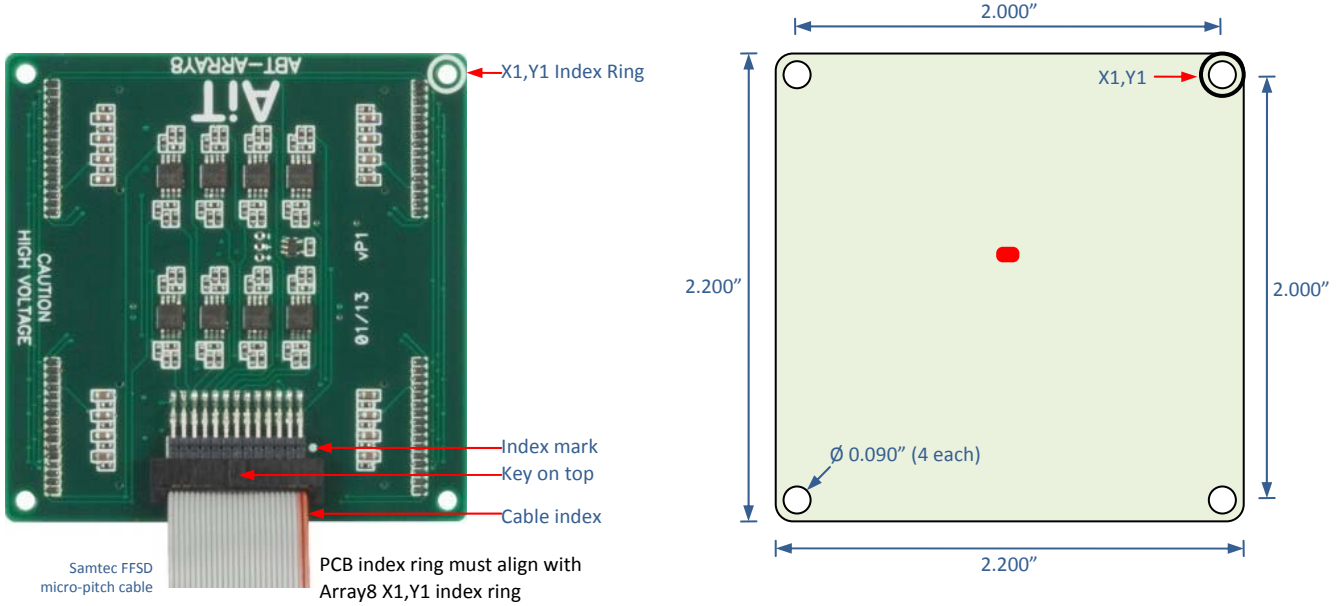

● Approximate location of temperature sensor on bottom side of PCB  
Measurement tolerance:  $\pm 0.020$ "

**Side View, Base Attached to Array**

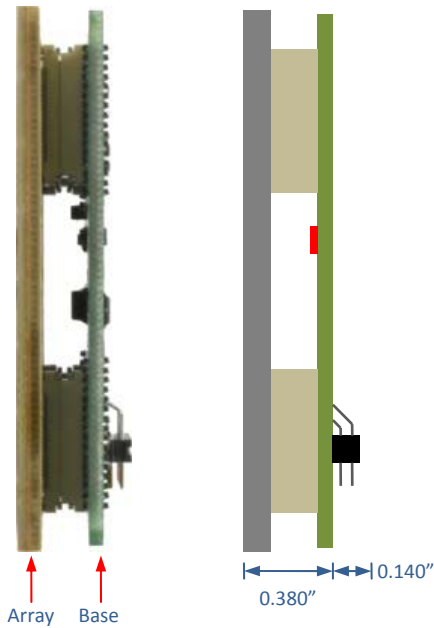

**Side View, Base Only**

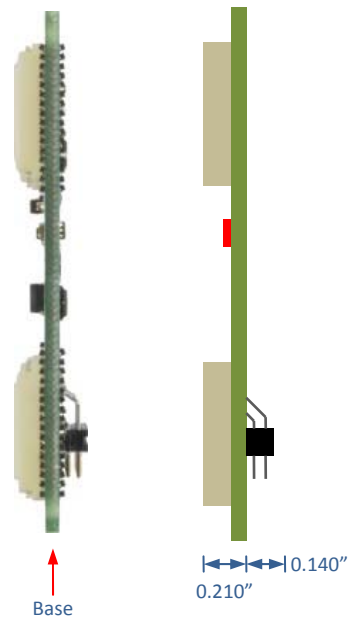

## 16-Channel SiPM Readout System

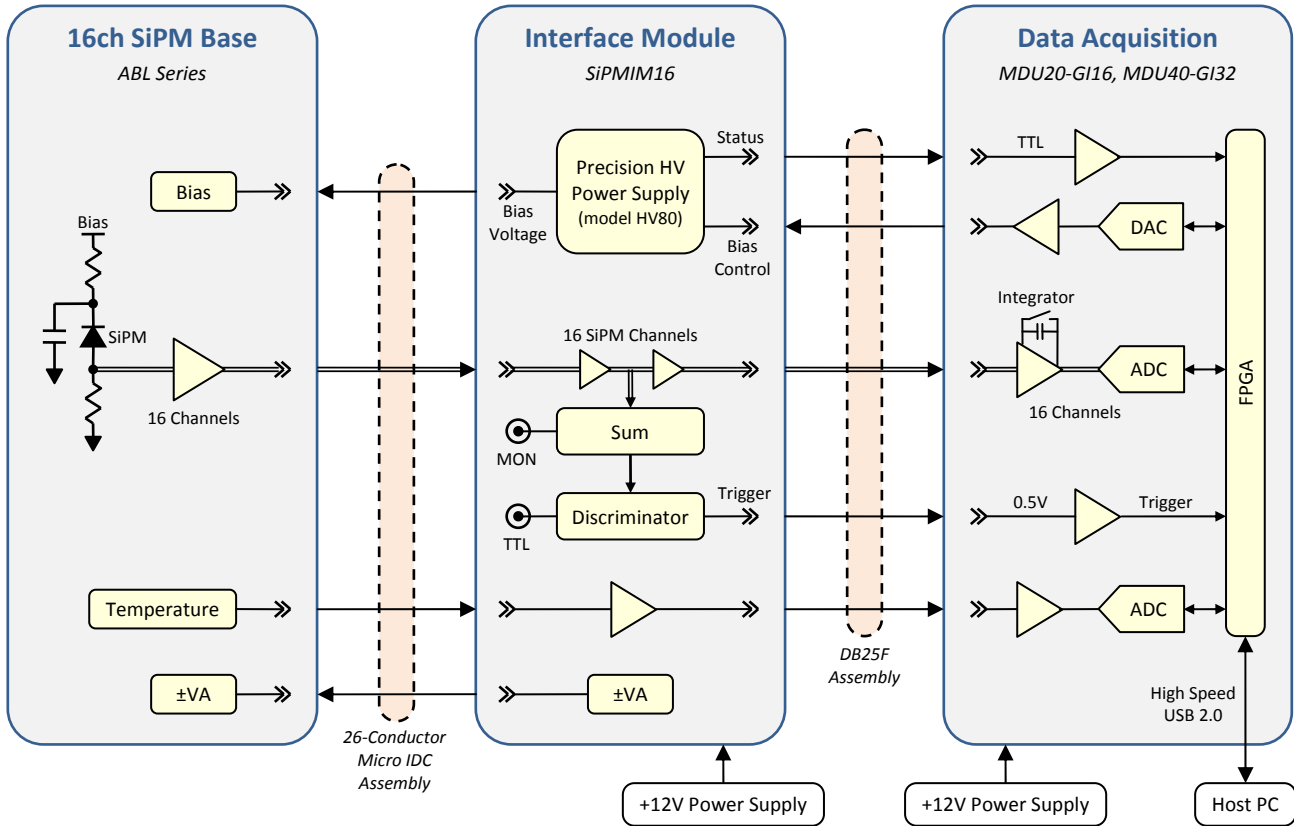

### Summary

A 16-channel SiPM array readout system consists of an ABL series 16-channel SiPM Base, a SiPMIM16 (“IM16”) Interface Module, and a 16/32-channel simultaneous sampling USB gated integrator model MDU20-GI16 or MDU40-GI32.

### SiPM Base and Interface Module

The ABL Base connects to the IM16 through a micro-pitch ribbon cable that permits versatile placement of the Base. The IM16 powers the Base, buffers SiPM signals, and forms a trigger from the discriminated analog sum of all SiPM signals.

### MDU20-GI16 and MDU40-GI32

The MDU20-GI16 has 16 simultaneous gated integrators followed by 16 simultaneous sampling ADCs. Each integrator is preceded by a 100ns analog delay to compensate for trigger latency. A 16-bit DAC controls SiPM bias and a 16-bit ADC monitors SiPM temperature. The IM16 connects to the MDU20-GI16 through a DB25F cable assembly. The MDU40-GI32 is a dual version of the MDU20-GI16 capable of controlling two IM16s.

## Safety Information



### **WARNING – High Voltage**

- High voltage may be present during operation
- High voltage stored on capacitors may be present after power is removed
- Improper handling may result in personnel injury or equipment damage

This high-voltage device must be used only by personnel trained and qualified in safe handling, installation, and operation of high-voltage equipment.



### **CAUTION – Electrostatic Discharge (ESD) Sensitivity**

The circuit board can be damaged by electrostatic discharge. Observe precautions for handling electrostatic sensitive devices. Handle only at static-safe workstations.

## High-Gain Photodetectors

High-gain photodetectors such as silicon photomultipliers may conduct damaging currents if exposed to high optical signal levels while the bias voltage is applied, or if the bias voltage exceeds the recommended operating range. These devices must be operated only in low-light conditions, and only within the manufacturer's recommended bias voltage range.

## Handling and Disassembly

This product may be provided with or without a protective enclosure. Disassembled enclosure components and circuit boards may contain sharp edges. Take appropriate safety precautions while assembling or disassembling the enclosure and handling disassembled components.

## Indoor Use Only

Do not operate this product in a wet/damp environment. Do not operate in an explosive atmosphere.

Use of this product, and AiT Instruments' liability related to use of this product, is further governed by AiT Instruments' standard terms and conditions of sale, which were provided upon purchase of this product.