

**Features**

Supports a 2x2 arrangement of SensL ArrayJ-30035-64P-PCB 8x8 SiPM arrays for a total of 16x16 SiPMs

Horizontal connectors located on the back, arrays located on the front

4-side tileable installation

Four encoded position signals for event centroid calculations: X+, X-, Y+, Y-

DC-coupled signal path

Low power consumption

Patented diode-coupled charge division readout, superior to traditional resistive readout

Improved spatial uniformity

Faster rise time

Reduced image noise

Precision temperature sensor

SensL's fast output signals are not connected

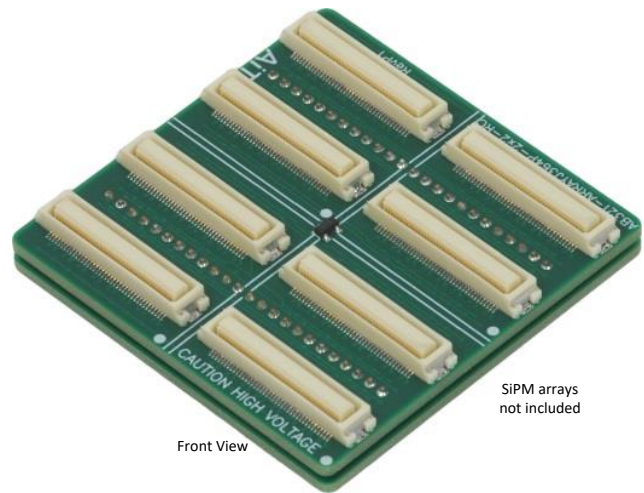

Front View

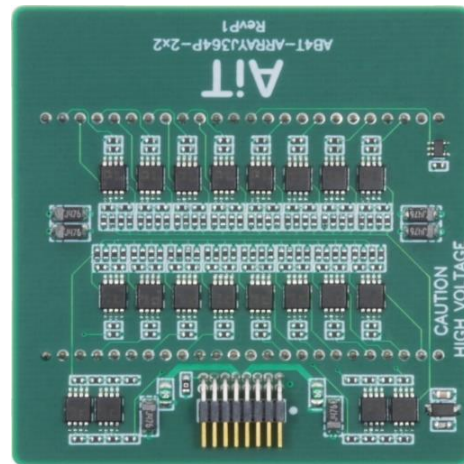

Back View

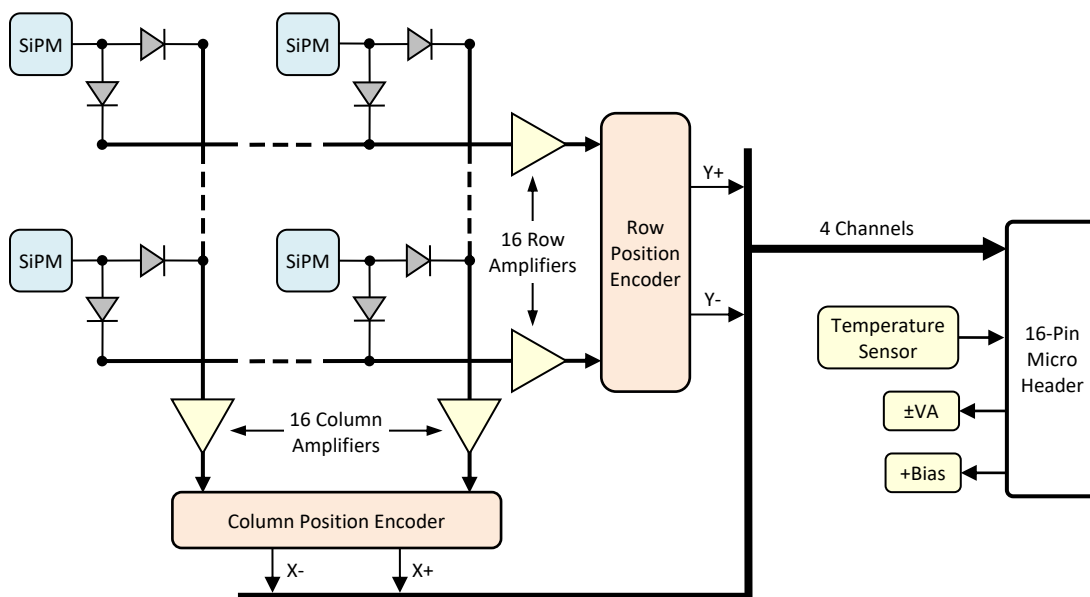

**Specifications**

**Position Signal Outputs**

Encoding	Charge division multiplexed to 4 output channels: X+, X-, Y+, Y-
Gain	750Ω transimpedance gain
Output voltage	0 → -1V into 100Ω
Output impedance	100Ω
Output current	50mA maximum

**Temperature Sensor**

Output voltage	500mV + 10mV per °C
Output current	10mA
Output impedance	100Ω
Accuracy	±0.5°C

**Bias Voltage**

	+29V typical (refer to SiPM data)
Voltage clamp	47V Zener diode 500mW maximum

**Amplifier Voltage (±VA)**

Current	±70mA typical at ±5.0V (Iq, no signal, no load)
---------	--

**Signal Connectors**

	Horizontal 16-pin 2-row header with 0.050" pin pitch
Mating assembly	Samtec FFSD-08-D-XX.XX-01-N (XX.XX = length in inches)

**Channel Map**

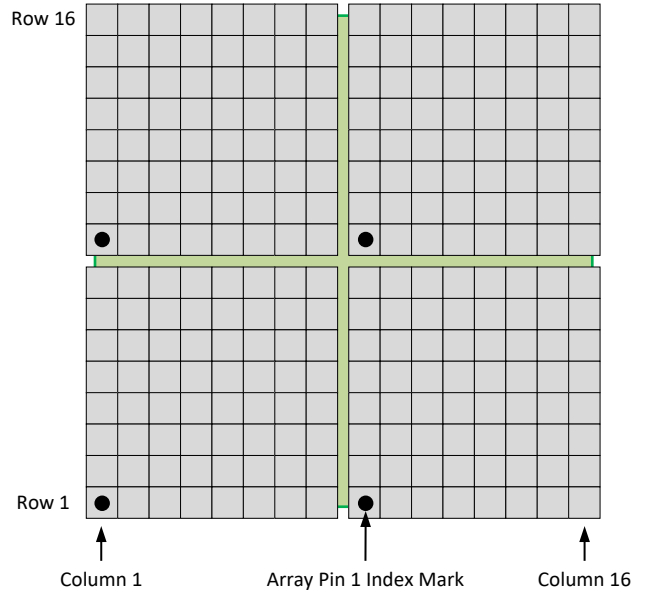

**Signal Connector**

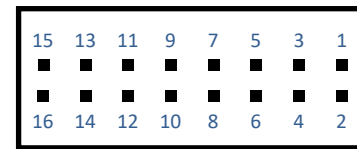

Side View

Pin	Function	Pin	Function
1	Temperature	2	Ground
3	X-	4	Ground
5	X+	6	Ground
7	-VA	8	Ground
9	+VA	10	Ground
11	Y-	12	Ground
13	Y+	14	Ground
15	+Bias	16	Ground

**Row and Column Encoder Weights**

Row# or Col# (for X- or Y-)	Row# or Col# (for X+ or Y+)	Fraction ideal	Fraction actual	% Error	Notes
1	16	0.0625	0.0625	0.00 %	Sum of X- and X+ fractions = <b>1.0625</b> Independent of signal position
2	15	0.1250	0.1250	0.00 %	
3	14	0.1875	0.1861	-0.75 %	
4	13	0.2500	0.2483	-0.68 %	
5	12	0.3125	0.3158	1.06 %	
6	11	0.3750	0.3731	-0.51 %	
7	10	0.4375	0.4412	0.85 %	
8	9	0.5000	0.5000	0.00 %	
9	8	0.5625	0.5618	-0.12 %	
10	7	0.6250	0.6250	0.00 %	
11	6	0.6875	0.6818	-0.83 %	
12	5	0.7500	0.7500	0.00 %	
13	4	0.8125	0.8021	-1.28 %	
14	3	0.8750	0.8876	1.44 %	
15	2	0.9375	0.9375	0.00 %	
16	1	1.0000	1.0000	0.00 %	

**Note:** Errors exclude component tolerances

**Output Signals**

- X- = (SiPM signal) \* (encoder gain) \* (X- fraction)
- X+ = (SiPM signal) \* (encoder gain) \* (X+ fraction)
- Y- = (SiPM signal) \* (encoder gain) \* (Y- fraction)
- Y+ = (SiPM signal) \* (encoder gain) \* (Y+ fraction)

Typical event position calculation:

$$\begin{aligned} \text{X column} &= (X+ - X-) / (X+ + X-) \\ \text{Y row} &= (Y+ - Y-) / (Y+ + Y-) \end{aligned}$$

**Example**

SiPM signal at column 4, row 3 (excluding encoder gain)

- X- = (Column 4 signal) \* 0.2483
- X+ = (Column 4 signal) \* 0.8021
- Y- = (Row 3 signal) \* 0.1861
- Y+ = (Row 3 signal) \* 0.8876

## Typical Signals

Source = Laser; Receiver = ABR4, channel 1, minimum gain; Bias = +30V; FFSD cable = 12"

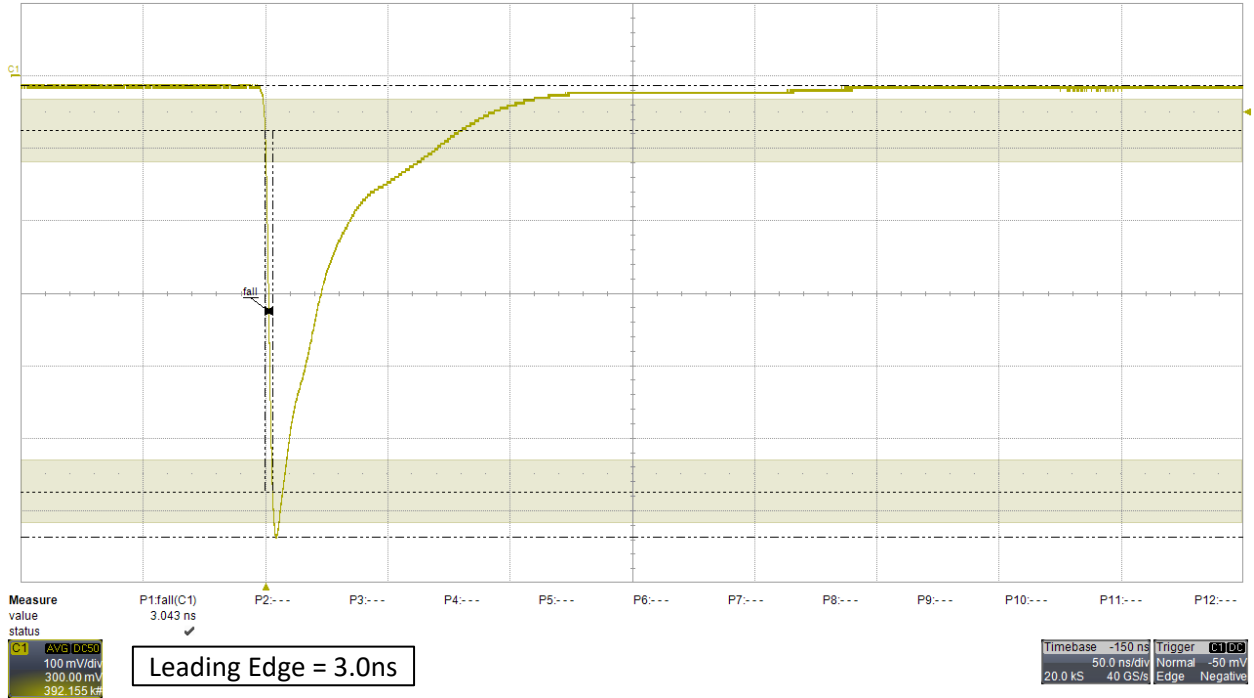

Source = LYSO emission; Receiver = ABR4, channel 4, minimum gain; Bias = +29.2V; FFSD cable = 12"; persistence display

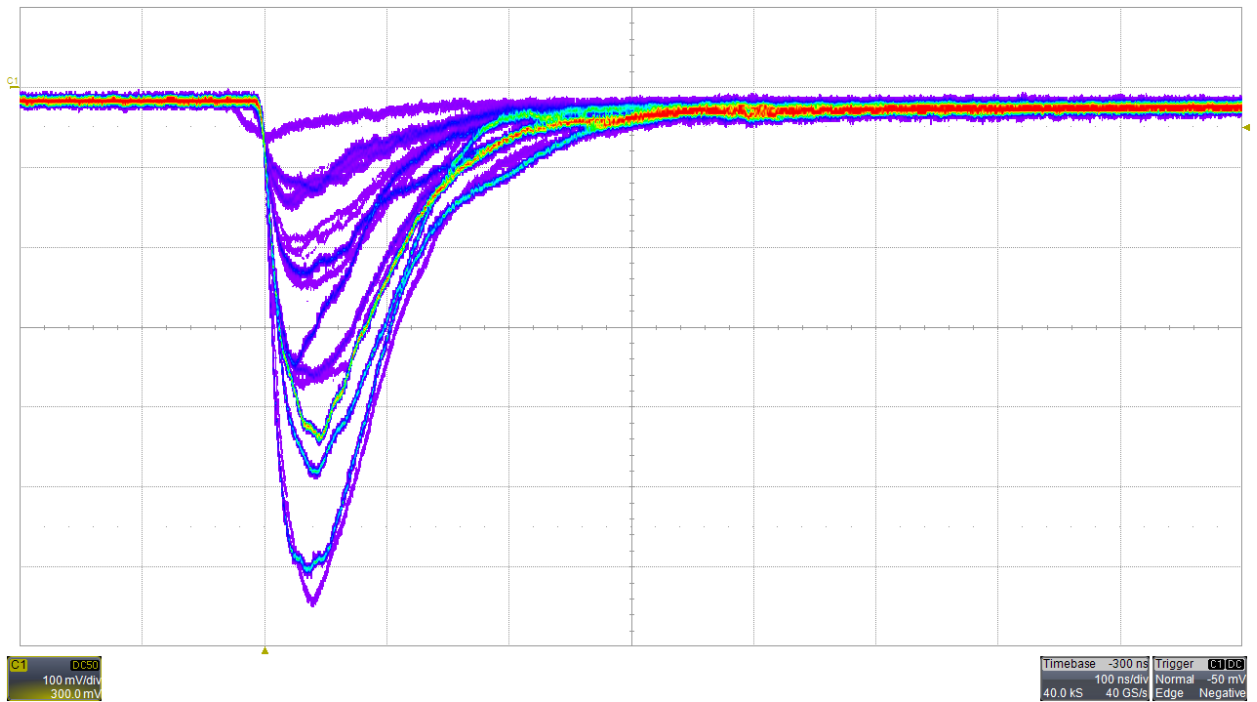

**Mechanical**

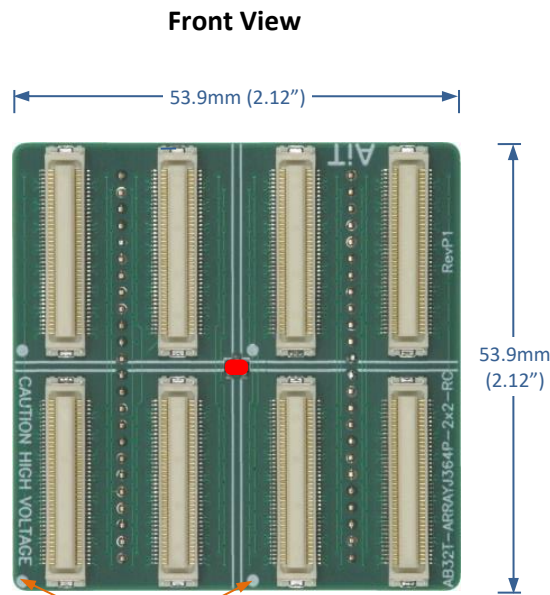

SiPM Array Pin 1 Index Marks

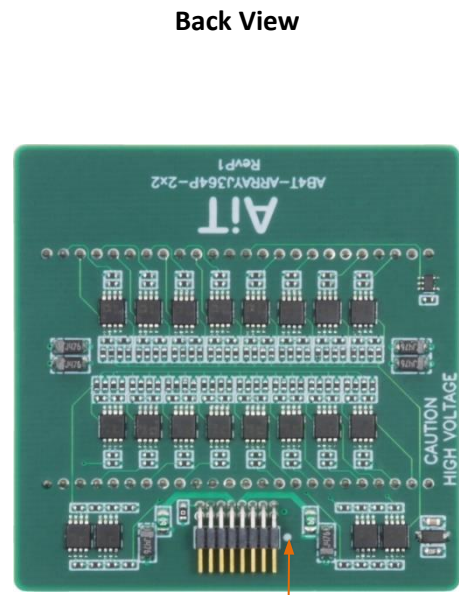

Align pin 1 with red conductor on the Samtec FFSD ribbon cable

● Temperature sensor

Measurement tolerance: ±0.020"

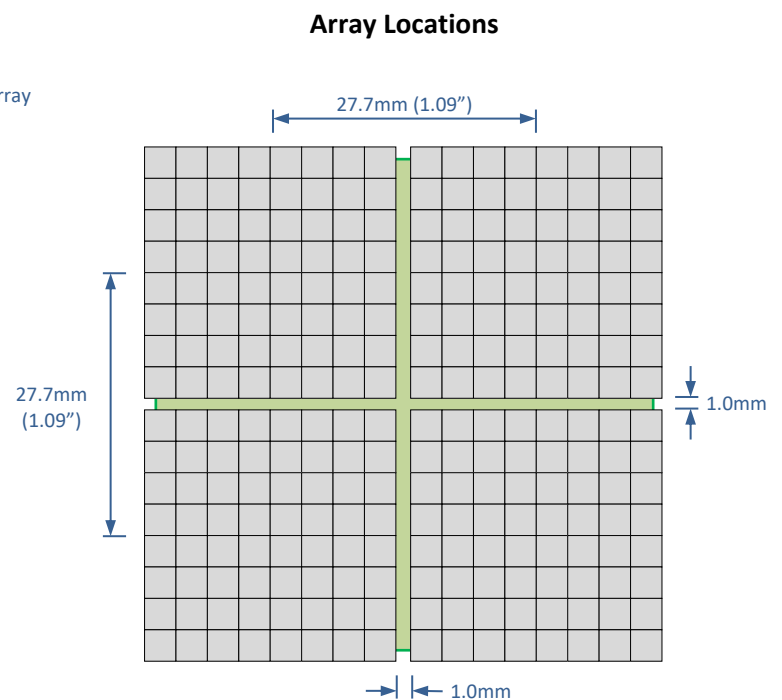
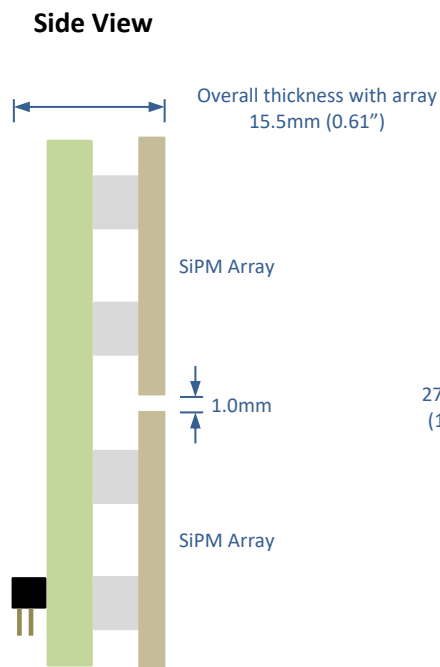

## Array Installation Guide

### STEP 1

Install the first array by carefully pressing on the array surface above the connectors until the array is firmly seated. An audible “click” will indicate that the connectors are seated.

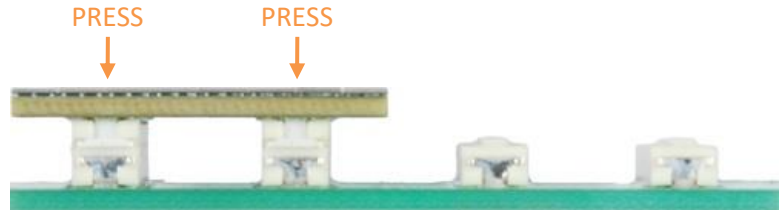

**CAUTION:** Do not contact the glass surface with any hard object. Any contact will damage the glass.

### STEP 2

Attach the second array by carefully pressing above the outer connector until the connector is firmly seated.

Do not press the inner connector first or the glass surfaces may touch and damage the glass.

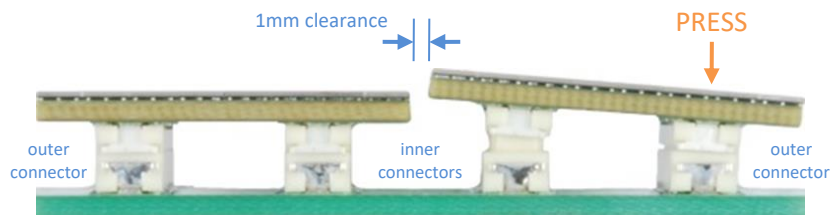

**CAUTION:** Do not contact the edges of the arrays with each other. Any contact will damage the glass.

### STEP 3

Press above the inner connector until the second array is firmly seated.

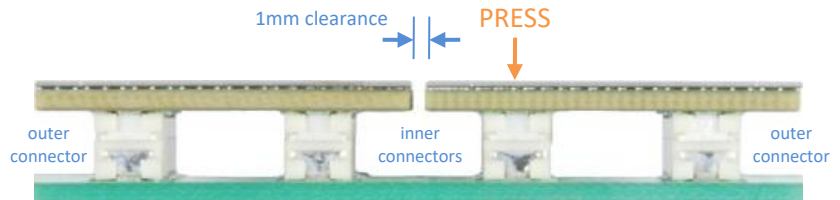

## Array Removal

To remove the arrays, reverse the installation procedure. Pull up the connectors labeled **PRESS**. Always pull up the inner connectors first.

### WARNING

Never insert the inner connectors first, or remove the outer connectors first. In this case, the small clearance between arrays increases the chance of contacting the surfaces and damaging the glass.

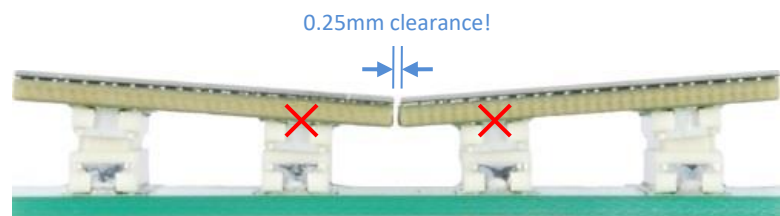

**Never insert inner connectors first**  
**Never pull up outer connectors first**

## 16-Channel Active Base Readout Kit

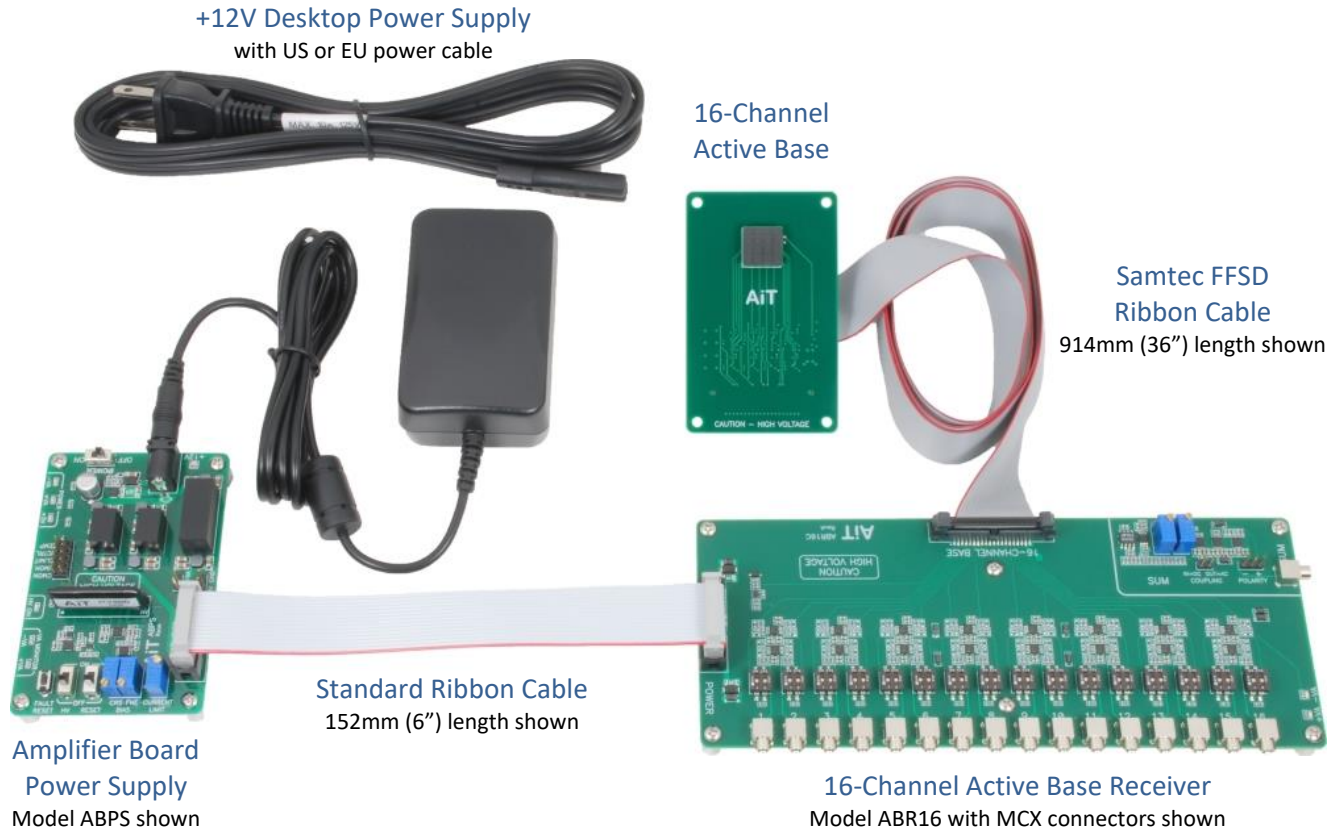

### Components

Each component is available separately. Refer to each datasheet for details.

The Active Base includes a 914mm (36") Samtec FFSD micro-pitch ribbon cable.

The Amplifier Board Power Supply includes a 12V desktop power supply and a HV80 bias voltage power supply.

The 16-channel Active Base Receiver includes a 152mm (6") power supply ribbon cable and a breakout board to connect any external power supply.

## Safety Information



### **WARNING – High Voltage**

- High voltage may be present during operation
- High voltage stored on capacitors may be present after power is removed
- Improper handling may result in personnel injury or equipment damage

This high-voltage device must be used only by personnel trained and qualified in safe handling, installation, and operation of high-voltage equipment.



### **CAUTION – Electrostatic Discharge (ESD) Sensitivity**

The circuit board can be damaged by electrostatic discharge. Observe precautions for handling electrostatic sensitive devices. Handle only at static-safe workstations.

## High-Gain Photodetectors

High-gain photodetectors such as silicon photomultipliers may conduct damaging currents if exposed to high optical signal levels while the bias voltage is applied, or if the bias voltage exceeds the recommended operating range. These devices must be operated only in low-light conditions, and only within the manufacturer's recommended bias voltage range.

## Handling and Disassembly

This product may be provided with a protective enclosure. Disassembled enclosure components and circuit boards may contain sharp edges. Take appropriate safety precautions while assembling or disassembling the enclosure and handling disassembled components.

## Indoor Use Only

Do not operate this product in a wet or damp environment. Do not operate in an explosive atmosphere.

Use of this product, and AiT Instruments' liability related to use of this product, is further governed by AiT Instruments' standard terms and conditions of sale, which were provided upon purchase of this product.